

Barrier

Ref. 41 321X

Street Furniture
Series 3000

Sineu Graff : Intelligent Design
for the town of tomorrow



➤ Presentation

Series 3000 barriers are marked by their contemporary design for a graceful street furniture range with clean lines.

This furniture has been designed and manufactured by Sineu Graff, experts in urban landscaping, in accordance with a sustainable development approach.

➤ Description

The painted galvanized steel barrier is made up of 2mm thick rectangular perimeter tubes with a 50x30mm section, filled with 2mm thick square tubes with a 30x30mm section.

The upper part is made up of 2mm thick rectangular tube with a 30x15mm section.

The flat iron on the median plane and the anchoring plates are 8mm thick.

Steel parts are zinc plated, then they undergo our powder blast process (after cleaning and shot blasting, they are coated with a first coat of epoxy powder, and then with a second coat of polyester powder).

4 anchoring points (plate mounted version).

Delivered assembled.

Weight: 15 kg (fixed anchor), 15 kg (plate anchor) or 24 kg (removable anchor).

➤ Colours

Colour shown:

Metallic grey 7100

Colours to select from RAL (satin) or AKZO NOBEL (sand) charts.

➤ Dimensions

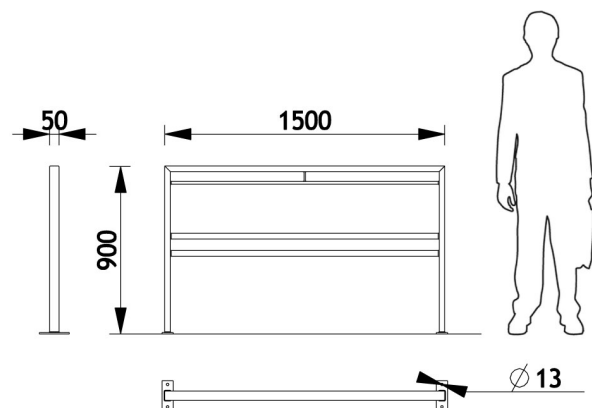

➤ Fixings device

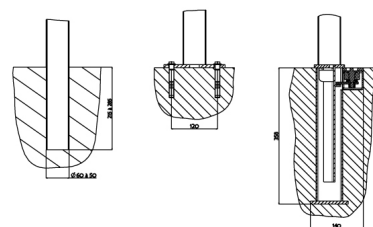

Fixing type A

Fixing type B

Fixing type C



LAUD
PRODUKTER

Møblering av offentlig rom



Street Furniture



SINEU GRAFF partner in Norway :
Laud Produkter AS
Salg: Rosenkrantz gt 15, 0160 Oslo
Administrasjon: Pb. 2, 4951 Risør
Org.nr: 911933500 - Telefon: 21904020

SINEU GRAFF info@sineugraff.com - www.sineugraff.com