

# Barrier

Ref. 41 281X

Street Furniture  
Series 2000

Sineu Graff : Intelligent Design  
for the town of tomorrow

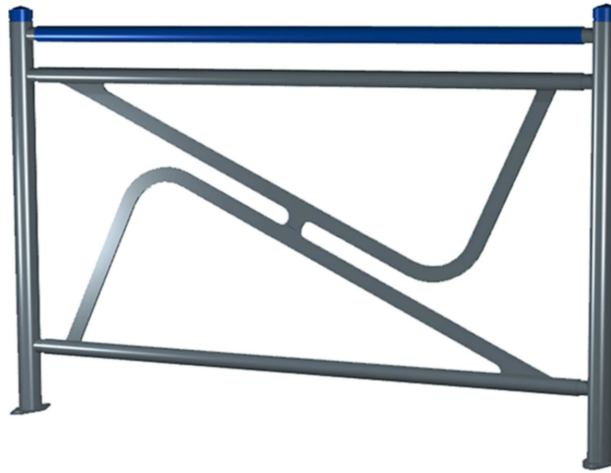

## ➤ Presentation

2000 Series barriers have been designed and developed using an eco-conception approach specific to SINEU GRAFF and are characterised by their contemporary design and clarity. Series 2000 equipment is intended specifically for dense urban spaces and is simple, discreet and efficient. Three cap shapes are available: classic, modern or contemporary.

This furniture has been designed and manufactured by Sineu Graff, experts in urban landscaping, in accordance with a sustainable development approach.

## ➤ Description

This Series 2000 double girder barrier is made up of uprights made of 2mm thick Ø60mm tubes, horizontal rails made of 1.5mm thick Ø40mm tubes, filling in 8mm thick sheet metal and contemporary aluminium caps.

The whole 2000 Series barrier is made of painted galvanized steel and the caps are in aluminium.

The anchoring plates are 8mm thick.

Steel parts are zinc plated, then they undergo our powder blast process (after cleaning and shot blasting, they are coated with a first coat of epoxy powder, and then with a second coat of polyester powder).

4 anchoring points (plate mounted version).

Delivered assembled.

Weight: 23kg.

## ➤ Colours

Colours shown:

Caps and upper rail: RAL 5011 Steel blue

Barrier: Metallic grey 7100

Colours to select from RAL (satin) or AKZO NOBEL (sand) charts.

## ➤ Dimensions

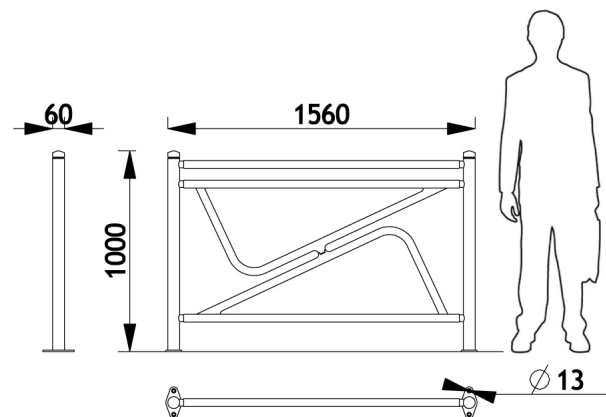

## ➤ Fixings device

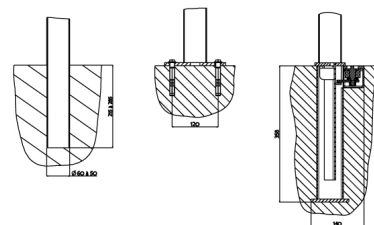

Fixing type A

Fixing type B

Fixing type C



**LAUD**  
PRODUKTER

Møblering av offentlig rom



Street Furniture



**SINEU GRAFF partner in Norway :**  
Laud Produkter AS  
Salg: Rosenkrantz gt 15, 0160 Oslo  
Administrasjon: Pb. 2, 4951 Risør  
Org.nr: 911933500 - Telefon: 21904020

SINEU GRAFF info@sineugraff.com - www.sineugraff.com