

275/K4FB 700F



ANTI-TERRORISM FIXED BOLLARDS WITH BASEMENT

The fixed 275/K4FB 700F PILOMAT have been designed and built with architectural appearance similar to that of the automatic PILOMAT and therefore also allows the combined use of both versions. Current models are the result of the dedication of more than 40 years in the field of access control and a twenty-year specialization in bollards.

GENERAL FEATURES

The fixed antiterrorism PILOMAT are used to separate and prevent vehicles from breaching the perimeter of the following areas: Research Centres Embassies, Police Headquarters, Military Bases, Ministerial Buildings Sites in Sensitive Areas. These items are designed to ensure antiterrorism defence, and must be cemented into the ground at a depth that meets the standards of breakout resistance.



PAG.1/3

PILOMAT

100% MADE IN ITALY



PILOMAT s.r.l.
www.pilomat.com / pilomat@pilomat.com
Via Zanica 17/p, 24050, Grassobbio (BG) Italy
Tel. +39.035.29.72.20
Copyright 2016© Pilomat S.r.l. All rights reserved

275/K4FB 700F_DATASHEET.16 REVIEW 12/05/2016

OPTIONAL ITEMS

PILOMAT BOLLARD 275/K4FB 700FFEV - NORMAL STEEL PAINTED

PILOMAT BOLLARD 275/K4FB 700FIXS - STAINLESS STEEL BRUSHED

RIBS ON FIXED CYLINDER - NORMAL STEEL

HEAD WITHOUT LOGO FOR PILOMAT 275/K4FB 700F

REFLECTING ADHESIVE STRIP - WHITE (NO-LOGO)

MULTILED FLASHING LIGHT - 27 LED POINTS

FLASHING LIGHT POWER CIRCUIT FOR FIXED BOLLARDS (MAX. 4 BOLLARDS)

PAINTING WITH RAL COLOUR ON REQUEST

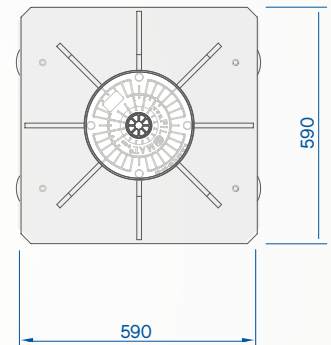
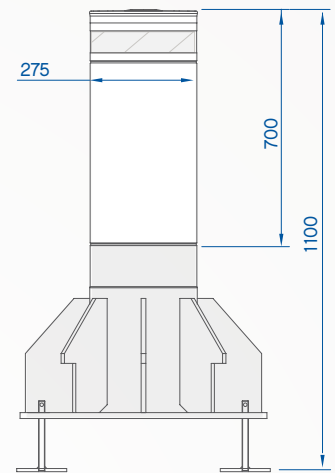

PILOMAT

100% MADE IN ITALY



275/K4FB 700F



FIXED CYLINDER	NORMAL STEEL FE510 - AISI 304 STAINLESS STEEL
FIXED CYLINDER DIAMETER	275mm
FIXED CYLINDER HEIGHT	700mm
FIXED CYLINDER THICKNESS	10mm
FIXED CYLINDER NORMAL STEEL FINISH	POLYESTER POWDER PAINT - STANDARD GREY ANTHRACITE
FIXED CYLINDER STAINLESS STEEL FINISH	AISI 304 STAINLESS STEEL BRUSHED COVERING
OTHER CYLINDER FINISH	RIBS ON CYLINDER
REFLECTING ADHESIVE STRIP	YES - HEIGHT 55mm
CONNECTION LINE TO CONTROL UNIT	STANDARD 10m (MAX. LENGTH 80m)
PROTECTION CLASS	IP67
IMPACT RESISTANCE (WITHOUT DEFORMATION)	250.000 J
BREAKOUT RESISTANCE	750.000 J

